

PRODOTTI / RICAMBI
PRODUCTS / SPARE PARTS
PRODUITS / PIÈCES DÉTACHÉES
PRODUKTE / ERSATZTEILE
PRODUCTOS / REPUESTOS

MICROBAR

01-11-2007



nuova simonelli

ESPLOSI MICROBAR

Legenda

I codici scritti in grassetto si riferiscono ai componenti impiegati attualmente. I codici impiegati prima sono scritti in corsivo con indicata a fianco la data di fine validità.

ESEMPIO:

03001531.1

03001531 *01/09/2007*

Il codice **03001531.1** è impiegato alla data di emissione dell'esplosivo ed ha sostituito il codice *03001530* dal *01/09/2007*

.

CARROZZERIA CABINET

M
I
C
R
O
B
A
R

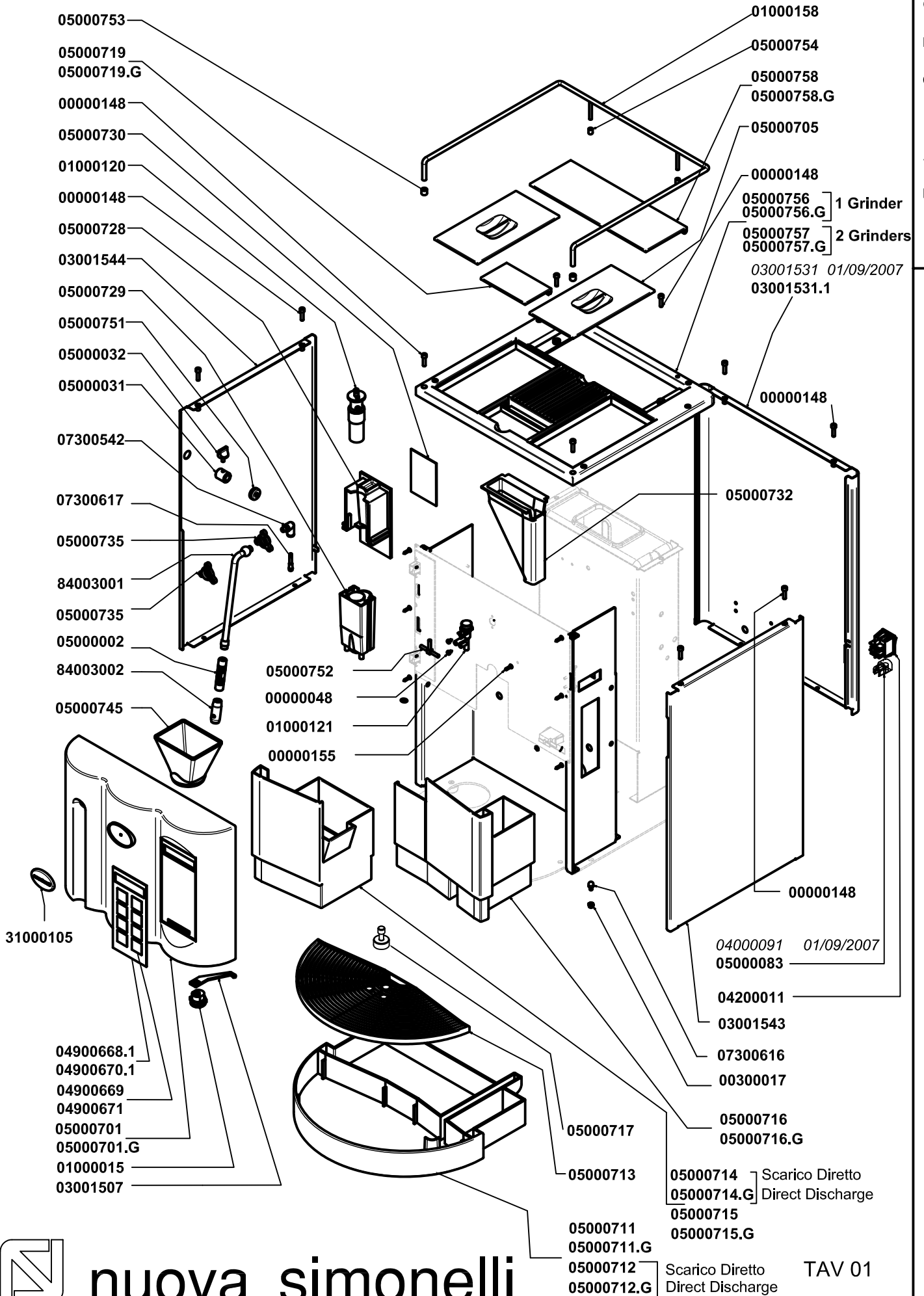

nuova simonelli

TAV 01

TELAIO TANICA TANK FRAME

M
I
C
R
O
B
A
R

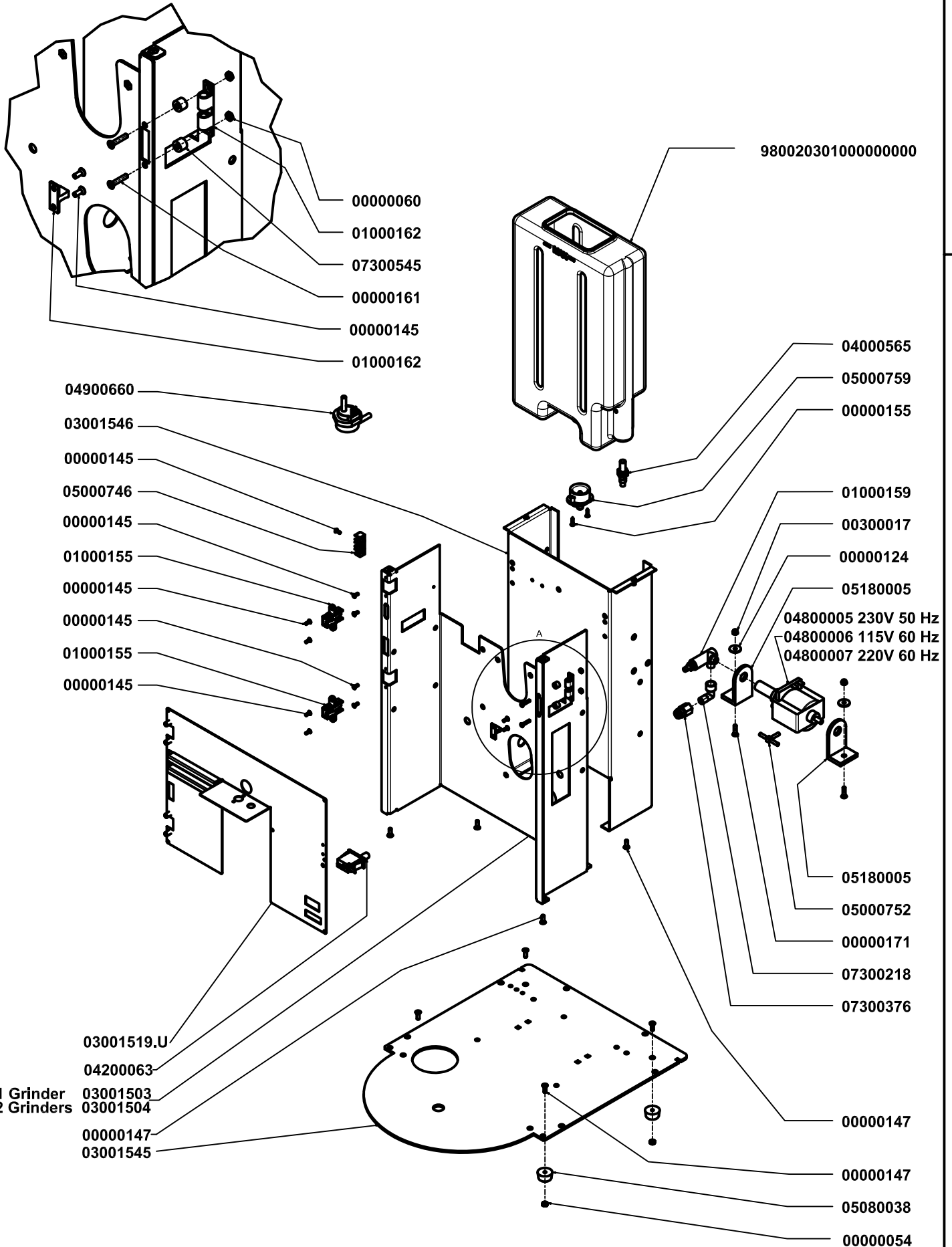

nuova simonelli

TAV 02A

TELAIO ATTACCO DIRETTO DIRECT CONNECTION FRAME

M
I
C
R
O
B
A
R

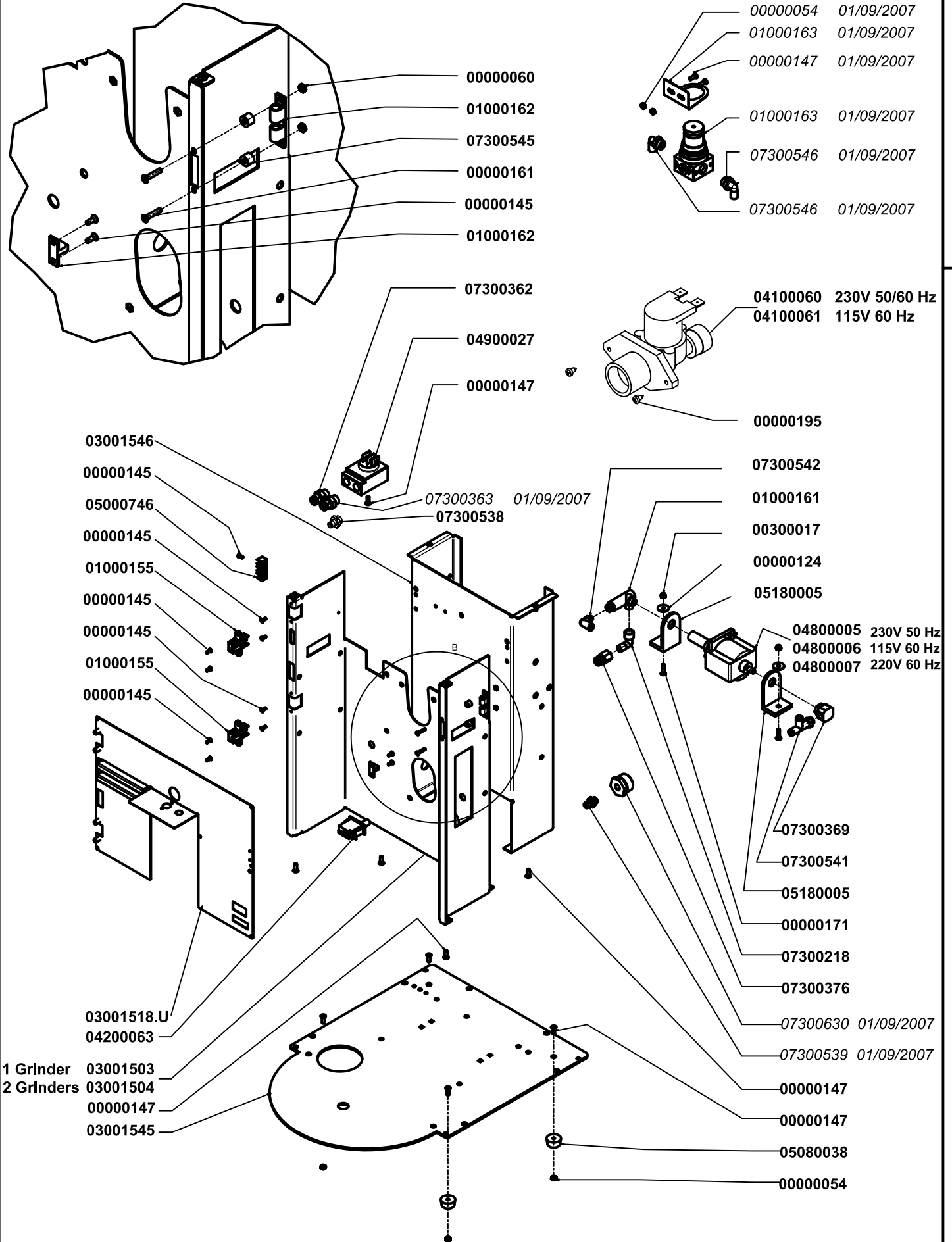

nuova simonelli

TAV 02B

CALDAIE BOILERS

M
I
C
R
O
B
A
R

1160001.R	SILICON PIPE \varnothing 7.5
1160001.W	SILICON PIPE \varnothing 7.5
11600004	SILICON PIPE \varnothing 9
11740001	TEFLON PIPE \varnothing 6
11740002	TEFLON PIPE \varnothing 4

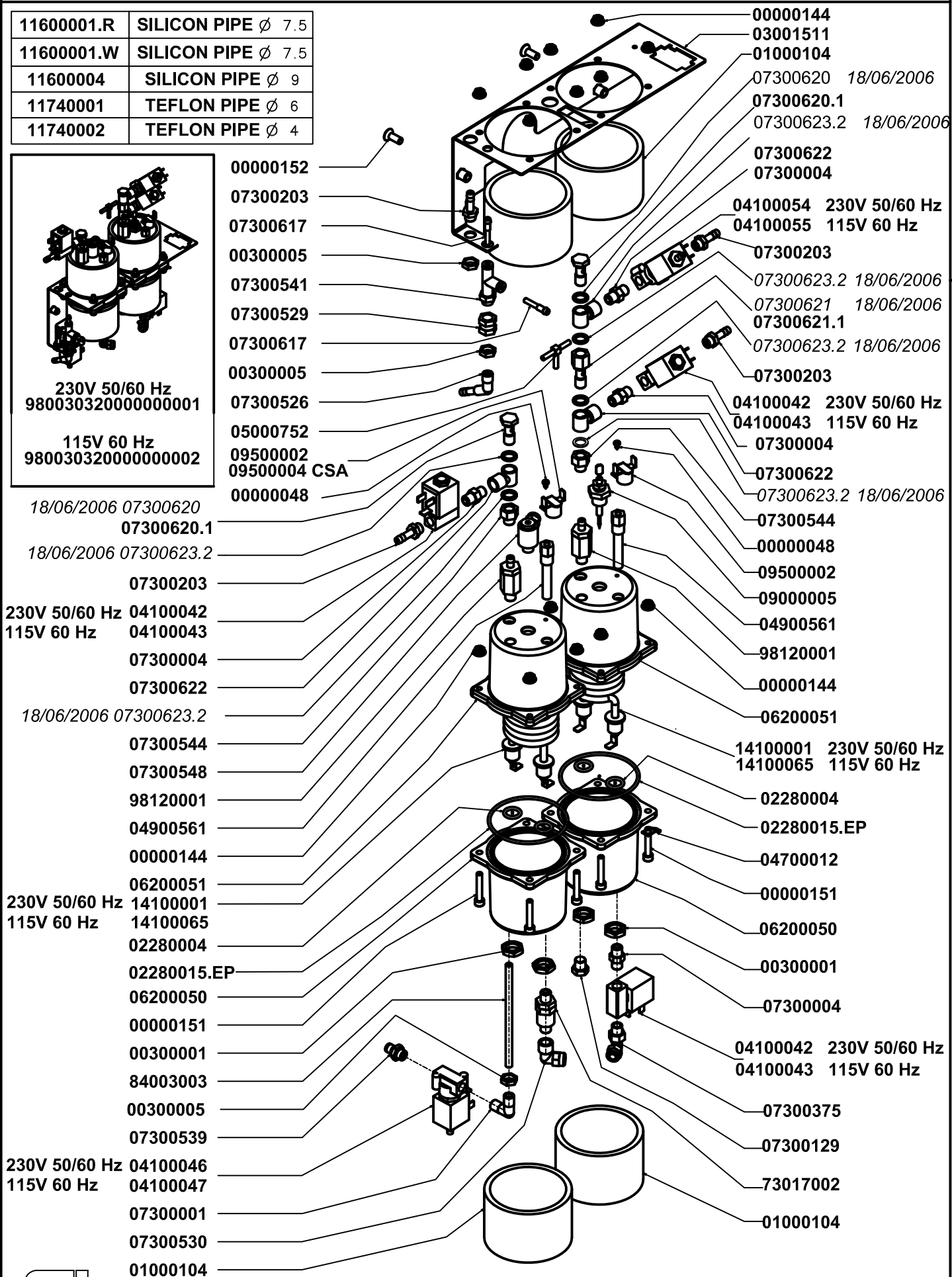
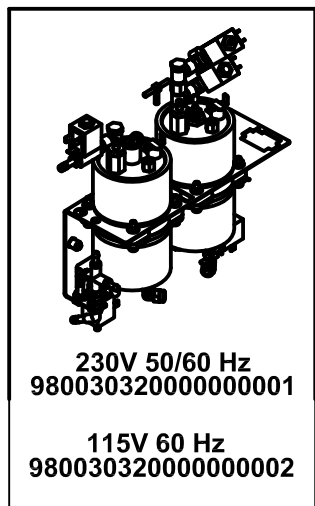

nuova simonelli

TAV 03

GRUPPO EROGAZIONE GROUP UNIT

M
I
C
R
O
B
A
R

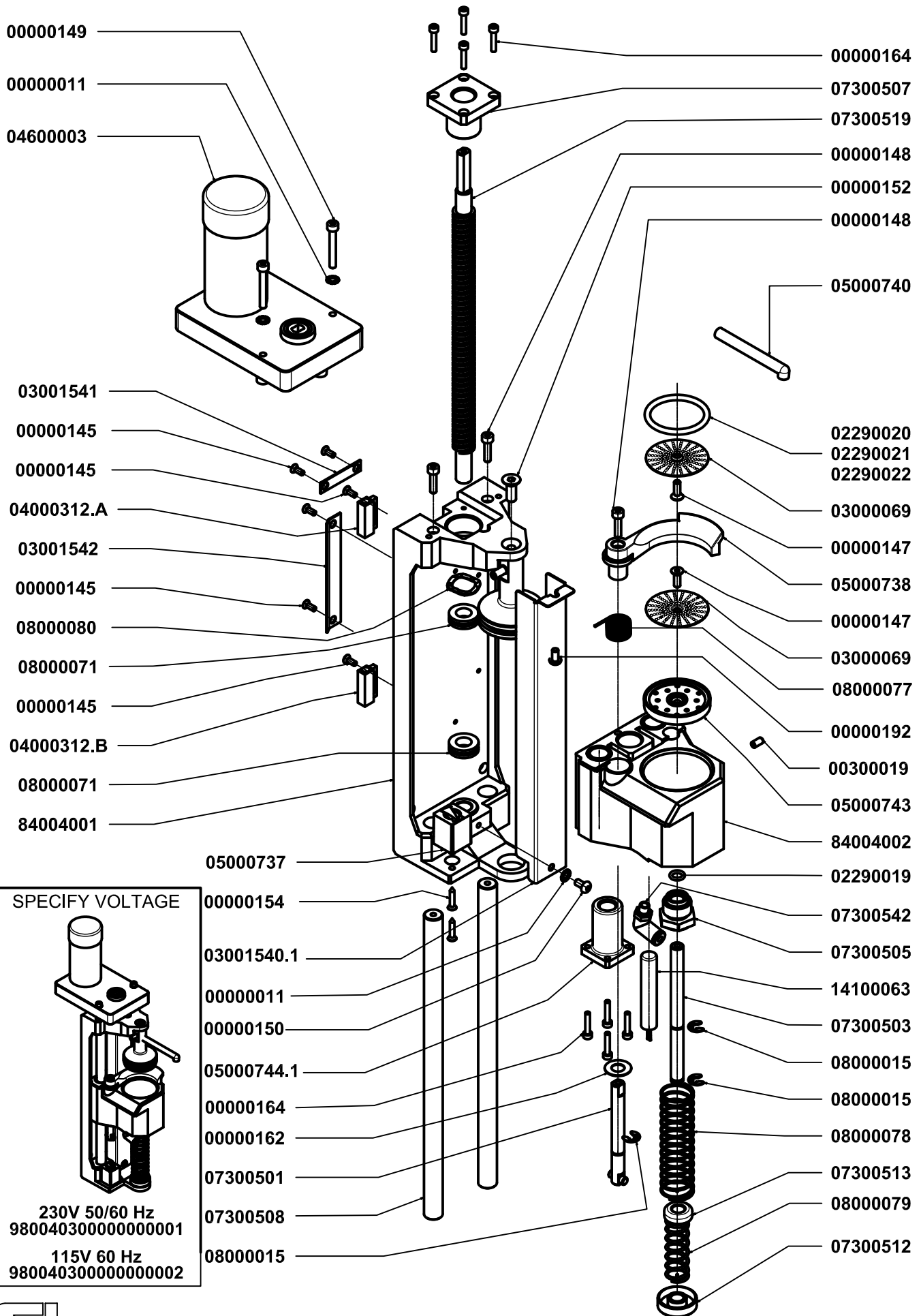

SPECIFY VOLTAGE

230V 50/60 Hz
980040300000000001
115V 60 Hz
980040300000000002



nuova simonelli

TAV 04

MACININI GRINGERS

SPECIFY VOLTAGE

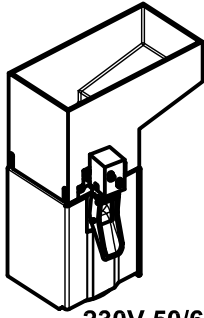

230V 50/60 Hz
980050400000000001
115V 60 Hz
980050400000000002

05000705

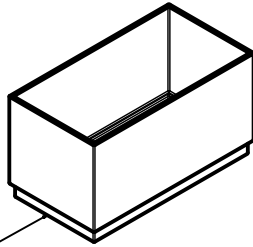
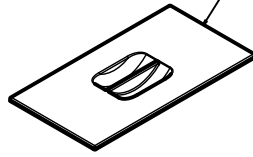

SPECIFY VOLTAGE

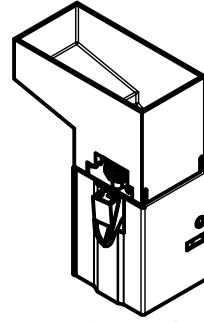

230V 50/60 Hz
980050300000000001
115V 60 Hz
980050300000000002

05000706

05000707
00000132
05000704

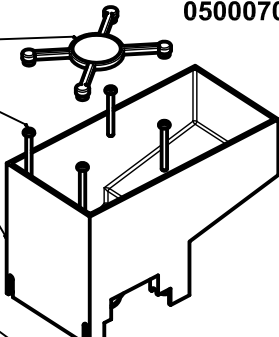

04000501 115V 60Hz
15050002 230V 50/60 Hz

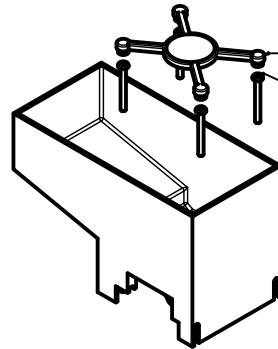

05000707
00000132
05000704

84005001
02290025



15800038



84005001
02290025

15800045
00000134



15800038
03001515
00000147



15800045
00000134

85060006
07300522

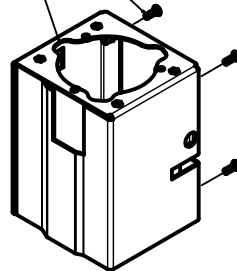

85060006
00000119

05000709
00000156

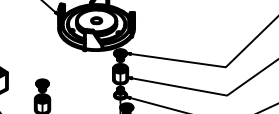

00000119
01000160
00000119



00000119

00000156



230V 04100052
115V 04100053

00000138
08000081

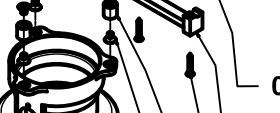

07300522
05000708

03001516



05000767
05000765
00000165
05000766
03001536

230V 50/60 Hz
980050410000000001

115V 60 Hz
980050410000000002

00000147

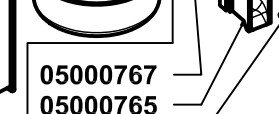

00000156
01000160

05000725
03001536



00000119

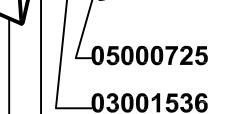

115V 60 Hz 84005003
230V 50/60 Hz 84005004

00000165
05000726



nuova simonelli

COMPONENTI ELETTRICI ELECTRIC PARTS

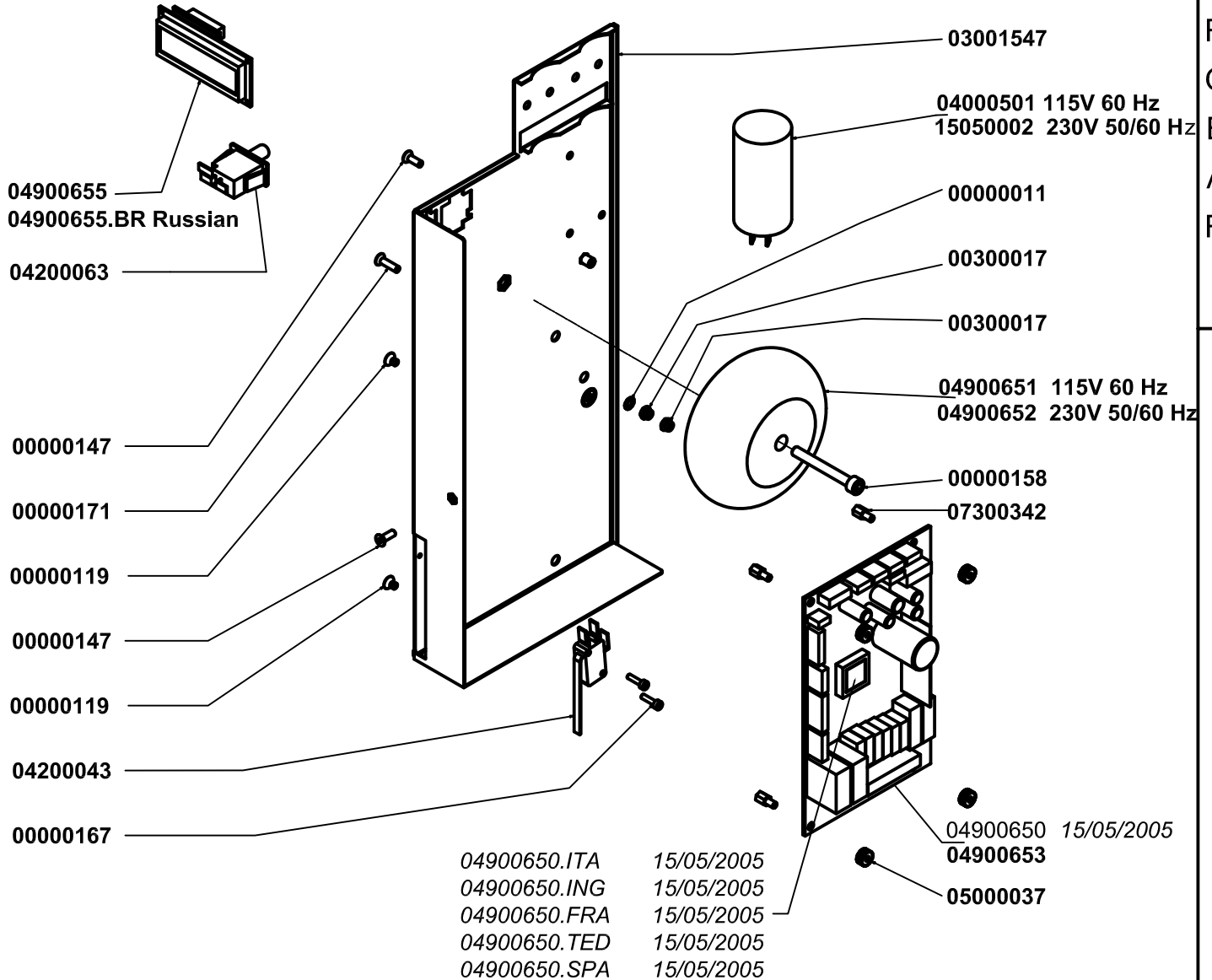

CODICE	FINE VALIDITA' END OF VALIDITY	DESCRIZIONE	DESCRIPTION
04000560	06/04/2003	IMPIANTO ELETTRICO	ELECTRIC WIRING
04000599		IMPIANTO ELETTRICO	ELECTRIC WIRING
04000598		IMPIANTO ELETTRICO CALDAIE	BOILERS ELECTRIC WIRING
04000585	15/05/2005	GUAINA	SHEATH
04000562		CAVO ALIMENTAZIONE 220 V CE	POWER SUPPLY CORD 208-240 V 50/60 Hz
04060002		CAVO ALIMENTAZIONE UL	POWER SUPPLY CORD UL
04900669		ADESIVO GRIGIO	GREY STICKER
04900671		ADESIVO NERO	BLACK STICKER



CODICE		DESCRIZIONE	DESCRIPTION
00000011		RONDELLA ZIGRINATA ZINCATA DIAM 4	GALVANISED KNURLED WASHER DIA. 4
00000048		VITE AUTOFILETTANTE 2,9X4,5 TCTCR	SELF-THREADING SCREW 2.9X4.5 TCTCR
00000054		DADO M4 UNI 5587	NUT M4 UNI 5587
00000060		DADO M3 DIN 934-8	NUT M3 DIN 934-8
00000119		VITE INOX M4x6 TSPTCR ISO 7046	STAINLESS STEEL SCREW M4x6 TSPTCR ISO 7046
00000124		RONDELLA ZINCATA D4.3X16X1.5	GALVANISED WASHER D4.3X16X1.5
00000132		VITE INOX M4X40 TCTCR ISO 7985	STAINLESS STEEL SCREW M4x40 TCTCR ISO 7985
00000134		VITE M3x6 TCTC UNI 6107	SCREW M3x6 TCTC UNI 6107
00000138		VITE M3x6 TCEI UNI 5931	SCREW M3x6 TCEI UNI 5931
00000144		DADO M5 FLANGIATO UNI 6923	NUT M5 FLANGED UNI 6923
00000145		VITE INOX M3x8 TSPEI UNI 5933	STAINLESS STEEL SCREW M3x8 TSPEI UNI 5933
00000147		VITE INOX M4x12 TSPEI UNI 5933	STAINLESS STEEL SCREW M4x12 TSPEI UNI 5933
00000148		VITE INOX M4x16 TCEI UNI 5931	STAINLESS STEEL SCREW M4x16 TCEI UNI 5931
00000149		VITE INOX M4x30 TCEI UNI 5931	STAINLESS STEEL SCREW M4x30 TCEI UNI 5931
00000150		VITE INOX M4x6 TBEI ISO 7380	STAINLESS STEEL SCREW M4x6 TBEI ISO 7380
00000151		VITE INOX M5x25 TCEI ISO 5931	STAINLESS STEEL SCREW M5x25 TCEI UNI 5931
00000152		VITE INOX M6x16 TSPEI UNI 5933	STAINLESS STEEL SCREW M6x16 TSPEI UNI 5933
00000154		VITE INOX TRUCIOLARE 3x16 TSPTCR DIN 7505 A	STAINLESS STEEL HARDBOARD SCREW 3x16 TSPTCR DIN 7505 A
00000155		VITE INOX TRUCIOLARE 3x12 TSPTCR DIN 7505 A	STAINLESS STEEL HARDBOARD SCREW 3x12 TSPTCR DIN 7505 A
00000156		VITE INOX AUTOFILETTANTE 2.9x19 TCTCR DIN 7981	SELF-THREADING STAINLESS STEEL SCREW 2.9x19 TCTCR DIN 7981
00000158		VITE INOX M6X55 TCEI UNI 5931	STAINLESS STEEL M6X55 TCEI UNI 5931
00000161		VITE INOX M3X16 TSPEI UNI 5933	STAINLESS STEEL M3X16 TSPEI UNI 5933
00000162		RONDELLA OTTONE D8,4x17x0,5	BRASS WASHER D8,4x17x0,5
00000164		VITE INOX M3X16 TCEI ISO 4762	STAINLESS STEEL M3X16 TCEI ISO 4762
00000165		VITE INOX M3x8 TCEI ISO 4762	STAINLESS STEEL M3x8 TCEI ISO 4762
00000167		VITE INOX M3X12 TCEI ISO 4762	STAINLESS STEEL M3X12 TCEI ISO 4762
00000171		VITE INOX M4X16 TSPEI UNI 5933	STAINLESS STEEL M4X16 TSPEI UNI 5933
00000192		VITE INOX M4x8 TE UNI 5739	STAINLESS STEEL M4x8 TE UNI 5939
00000195		VITE AUTOF INOX 3,9X9,5 TC/TCR	SELF-THREADING STAINLESS STEEL SCREW 3.9x9.5 TC/TCR
00300001		DADO OT 1/4 GAS SPESSORE 5	BRASS NUT 1/4 GAS SPESSOR 5
00300005		DADO OT 1/8 GAS AGG.22.07.96	BRASS NUT 1/8 GAS AGG.22.07.96
00300017		DADO INOX M4 AUTOBLOCCANTE DIN 982	SELF-LOCKING STAINLESS STEEL NUT M4 DIN 982
00300019		GRANO INOX M4X6 UNI 5923	STAINLESS STEEL DOWEL M4X6 UNI 5923
01000015		SERRATURA	LOCK
01000104		ISOLANTE CALDAIA	BOILER INSULATION
01000120		CAPPUCCINATORE NSF	CAPPUCCINO MAKER NSF
01000121		REGISTRO ARIA	AIR ADJUSTER
01000155		CERNIERA SPORTELLO MICROBAR	MICROBAR DOOR HINGE
01000158		CORNICE INOX COPERCHIO CARENA MICROBAR 5LT	STAINLESS STEEL COVER FRAME 5LITRE MICROBAR BOTTOM
01000159		BY-PASS DESTRO REGOLABILE PER ELETTROPOMPA + OR	RIGHT ADJUSTABLE BY-PASS FOR MOTOR PUMP + OR
01000160		ANTIVIBRANTE D10x10 M4 FF	VIBRATION-DAMPING DEVICE D10x10 M4 FF
01000161		BY-PASS DESTRO REGOLABILE PER	ANTI-VIBRATION D10x10 M4 FF
01000162		SCROCCHETTO COMPLETO MICROBAR	MICROBAR LOCK COMPLETE
01000163	01/09/2007	RIDUTT. DI PRESSIONE 0-8 BAR	PRESSURE REDUCTOR 0-8BAR
02280004		GUARN. OR 115 D.17 EP851	GASKET OR 115 D.17 EP851
02280015.EP		GUARNIZ. OR3281 71,12x2,62	GASKET OR3281 71,12x2,62
02290019		GUARNIZIONE OR R6 DF801	GASKET OR R6 DF801
02290020		GUARNIZIONE OR 140/4137 D.41.5 VERDE	GASKET OR 140/4137 D.41.5 GREEN
02290021		GUARNIZIONE OR 140/4137 D.41.5 ROSSO	GASKET OR 140/4137 D.41.5 RED
02290022		GUARNIZIONE SPECIALFLEX D.41.5 BLU/ROSSO	GASKET SPECIALFLEX D.41.5 BLUE/RED
02290025		GUARNIZIONE MACININO OR3193	GRINDER GASKET OR3193
03000069		DOCCIA INOX D.40	STAINLESS STEEL SPOUT D.40
03001503		TELAIO SUPPORTO GRUPPO 1M	MICROBAR SUPPORT FRAME GROUP 1 GRINDER
03001504		TELAIO SUPPORTO GRUPPO 2 MACININI MICROBAR	MICROBAR SUPPORT FRAME GROUP 2 GRINDERS
03001507		PIASTRINA SERRATURA PORTA MICROBAR	MICROBAR DOOR LOCK PLATE
03001511		STAFFA SUPPORTO CALDAIA MICROBAR	MICROBAR BOILER SUPPORT BRACKET
03001515		CARTER MACININO DX MICROBAR	MICROBAR RIGHT GRINDER CASING
03001516		CARTER MACININO SX MICROBAR	MICROBAR LEFT GRINDER CASING
03001519.U		CHIUSURA INT.INVOLUCRO COMANDI	INTERNAL COMMAND ENCLOSURE
03001531	01/09/2007	CARENA RETRO INOX MICROBAR	MICROBAR REAR STAINLESS STEEL CASE
03001531.1		CARENA RETRO INOX MICROBAR CSA	MICROBAR REAR STAINLESS STEEL CASE CSA
03001536		LINGUETTA SCIVOLO CAFFE' MICROBAR	MICROBAR COFFEE CHUTE TAB
03001540.1		LAMIERINO PROTEZIONE GRUPPO	GROUP PROTECTION PLATE
03001541		PIASTRINA BLOCCACAVI PICCOLA SUPP. GRUPPO MICROBAR	MICROBAR UNIT SMALL UPPER CABLE CLAMP
03001542		PIASTRINA BLOCCACAVI GRANDE SUPP. GRUPPO MICROBAR	MICROBAR UNIT LARGE UPPER CABLE CLAMP
03001543		CARENA DX INOX MICROBAR 5LT	5 LITRE MICROBAR RIGHT STAINLESS STEEL CASE
03001544		CARENA SX INOX MICROBAR 5LT	5 LITRE MICROBAR LEFT STAINLESS STEEL CASE
03001545		BASE TELAIO 5LT MICROBAR	5 LITRE MICROBAR BASE FRAME
03001546		SUPPORTO VASCHETTA ACQUA 5LT MICROBAR	5LITRE MICROBAR WATER CHAMBER SUPPORT
03001547		SCATOLA CENTR. MICROBAR 5LT	5 LITRE MICROBAR CENTRAL BOX
04000091	01/09/2007	FISSACAVO 4228/B	CABLE CLAMP 4228/B
04000312.A		SENSORE MAGNETICO L400	MAGNETIC SENSOR L400
04000312.B		SENSORE MAGNETICO L520	MAGNETIC SENSOR L520
04000501		CONDENSATORE 25mF 450V FASTON 6.3 FONDO PIANO 115V UL	CAPACITOR 25mF 450V FASTON 6.3 FLAT BOTTOM 115V UL
04000560	06/04/2003	IMP. ELETTTRICO MICROBAR 2003	MICROBAR WIRING 2003
04000562		CAVO ALIMENTAZIONE CE 3x1,5 + SPINA 232	POWER SUPPLY CABLE CE 3x1.5 + PLUG 232
04000565		SENSORE MAGNETICO M8X30 L=300	MAGNETIC SENSOR M8X30 L=300
04000585	15/05/2005	GUAINA VETROELASTOMERO ROSSO D.10	GLASS-ELASTOMER SHEATH RED D.10
04000598		IMP. ELETT. "CORTO" CALDAIE	SHORT WIRING FOR BOILERS ASSEMBLY
04000599		IMPIANTO ELETTTRICO MICROBAR 2004	MICROBAR 2004ELECTRICAL SYSTEM
04060002		CAVO ALIMENTAZIONE UL AWG 3x18 SJT + SPINA 730	POWER SUPPLY CABLE UL AWG 3x18 SJT + PLUG 730
04100042		ELETT. 2VIE 1/8" F2 230v 50/60Hz	ELECTR. 2-WAY 1/8" F2 115V 50/60Hz
04100043		ELETT. 2VIE 1/8" F2 115V 60Hz	ELECTR. 2-WAY 1/8" F2 115V 60Hz
04100046		ELETT. 3VIE 1/8" F1,5 230V 50/60Hz SCARICO PORTAGOMMA	ELECTR. 3-WAY 1/8" F1.5 230V 50/60Hz HOSE CLAMP OUTLET
04100047		ELETT. 3VIE 1/8" F1,5 115V 60Hz SCARICO PORTAGOMMA	ELECTR. 3-WAY 1/8" F1.5 115V 60Hz HOSE CLAMP OUTLET
04100052		SOLENOIDE 230V 50Hz	SOLENOID 230V 50Hz
04100053		SOLENOIDE 115V 60Hz	SOLENOID 115V 60Hz
04100054		ELETT. 3VIE 1/8" F2 230V 50/60Hz SCARICO PORTAGOMMA	ELECTR. 3-WAY 1/8" F2 230V 50/60Hz HOSE CLAMP OUTLET
04100055		ELETT. 3VIE 1/8" F2 115V 60Hz SCARICO PORTAGOMMA	ELECTR. 3-WAY 1/8" F2 115V 60Hz HOSE CLAMP OUTLET
04100060		E.V. NC 2VIE 3/4-JG 6 DIRITTA 230V 50/60Hz	2-WAY SOLENOID VALVE 3/4-JG 6 230V 50/60Hz
04100061		E.V. NC 2VIE 3/4-JG 6 DIRITTA 115V 60Hz	2-WAY SOLENOID VALVE 3/4-JG 6 115V 60Hz
04200011		INTERRUTTORE BIPOLARE LUMINOSO	TWO-POLE LUMINOUS SWITCH
04200043		MICROSWITCH	MICRO-SWITCH
04200063		MICROSWITCH PORTA MICROBAR	MICRO-SWITCH MICROBAR DOOR
04600003		MOTORIDUTTORE GRUPPO MICROBAR	MICROBAR UNIT GEAR MOTOR
04700012		FASTON DI MASSA D.5	GROUND CONNECTION FASTOM D.5
04800005		POMPA ELETTROMECCANICA 230V 50Hz	VIBRATION PUMP 230V 50Hz
04800006		POMPA ELETTROMECCANICA 115V 60Hz	VIBRATION PUMP 115V 60Hz

04800007		POMPA ELETTROMECCANICA 220V 60Hz	VIBRATION PUMP 220V 60HZ
04900027		DOSATORE VOLUMETRICO	FLOWMETER
04900561		SONDA TEMPERATURA CALDAIA 1/8"	BOILER TEMPERATURE PROBE 1/8"
04900650	15/05/2005	SCHEDA ELETTRONICA MICROBAR	ELECTRONIC BOARD
04900651		TRASFORMATORE 115V/18V 150VA 60Hz TA50 FUSE 130°C	TRANSFORMER 115V/18V 150VA 60Hz TA50 FUSE 130°C
04900652		TRASFORMATORE 230V/18V 150VA 50/60Hz TA50 FUSE 130°C	TRANSFORMER 230V/18V 150VA 50/60Hz TA50 FUSE 130°C
04900653		SCHEDA ELETR. MICROBAR 2004 (COMPLETA DI 2 PONTICELLI)	MICROBAR 2004 ELECTRONIC CARD (WITH TWO BRIDGES)
04900655		SCHEDA DISPLAY BLU MICROBAR	MICROBAR DISPLAY CARD BLUE
04900655.BR		SCHEDA DISPLAY BLU MICROBAR RUSSIAN	MICROBAR DISPLAY CARD BLUE RUSSIAN
04900660		DOSATORE VOLUMETRICO NSF BASSA PRESSIONE	VOLUMETRIC DOSING DEVICE NSF LOW PRESSURE
04900668.1		PULSANTIERA A MEMBRANA MICROBAR 2004 GRIGIO	MICROBAR 2004 MEMBRANE PUSH-BUTTON PANEL GREY
04900669		SET ADESIVI PERSONALIZZAZIONE PULSANTIERA MICROBAR GRIGIO	SET OF PERSONALISED LABELS PUSH-BUTTON PANEL GREY
04900670.1		PULSANTIERA A MEMBRANA MICROBAR 2004 NERO	MICROBAR 2004 MEMBRANE PUSH-BUTTON PANEL BLACK
04900671		SET ADESIVI PERSONALIZZAZIONE PULSANTIERA MICROBAR NERO	SET OF PERSONALISED LABELS PUSH-BUTTON PANEL BLACK
05000002		GOMMINO PROTEZIONE LANCIA D.8	NOZZLE PROTECTION GROMMET D.8
05000031		ANELLO REGOLAZIONE CAPPUCCINATORE	CAPPUCCINO MAKER ADJUSTMENT RING
05000032		POMELLO FILETTATO	THREADED KNOB
05000037		GHIERA FILETTATA PER PANNELLI M4 BIANCO	THREADED LOCK NUT FOR PANELS M4 WHITE
05000083		BLOCCACAVO SR 11-2	CABLE BLOCK SR 11-2
05000701		PORTA FRONTALE MICROBAR NERO	MICROBAR FRONT PANEL SUPPORT BLACK
05000701.G		PORTA FRONTALE MICROBAR GRIGIO	MICROBAR FRONT PANEL SUPPORT GREY
05000704		CAMPANA CAFFE' MICROBAR	MICROBAR COFFEE FUNNEL
05000705		COPERCHIO CAMPANA CAFFE' MICROBAR	MICROBAR COFFEE FUNNEL COVER
05000706		PROLUNGA CAMP. CAFFE' MICROBAR	COFFEE BEAN CONTAINER EXTENSION
05000707		PROTEZIONE INTERNA CAMPANA CAFFE' MICROBAR	MICROBAR COFFEE FUNNEL INSIDE PROTECTION
05000708		MORSETTO DX VITE REGOLAZIONE MICROBAR	MICROBAR RIGHT ADJUSTMENT SCREW CLAMP
05000709		MORSETTO SX VITE REGOLAZIONE MICROBAR	MICROBAR LEFT ADJUSTMENT SCREW CLAMP
05000711		VASCHETTA RACCOGLI ACQUA MICROBAR NERO	MICROBAR WATER COLLECTION TRAY BLACK
05000711.G		VASCHETTA RACCOGLI ACQUA MICROBAR GRIGIO	MICROBAR WATER COLLECTION TRAY GREY
05000712		VASCHETTA RACC. ACQUA SCARICO NERO	MICROBAR WATER COLLECTION TRAY BLACK DIRECT DISCHARGE
05000712.G		VASCHETTA RACC. ACQUA SCARICO GRIGIO	MICROBAR WATER COLLECTION TRAY GREY DIRECT DISCHARGE
05000713		RETINA PIANO LAVORO MICROBAR CON GALLEGGIANTE	WORKING HAIMET WITH WITH FLOAT
05000714		CASSETTO SX RAC.FONDI SCARICO NERO	MICROBAR LEFT DREGS COLLECTION TRAY BLACK DIRECT DISCHARGE
05000714.G		CASSETTO SX RAC.FONDI SCARICO GRIGIO	MICROBAR LEFT DREGS COLLECTION TRAY GREY DIRECT DISCHARGE
05000715		CASSETTO SX RACCOGLI FONDI MICROBAR NERO	MICROBAR LEFT DREGS COLLECTION TRAY BLACK
05000715.G		CASSETTO SX RACCOGLI FONDI MICROBAR GRIGIO	MICROBAR LEFT DREGS COLLECTION TRAY GREY
05000716		CASSETTO DX RACCOGLI POLVERE MICROBAR NERO	MICROBAR RIGHT POWDER COLLECTION TRAY BLACK
05000716.G		CASSETTO DX RACCOGLI POLVERE MICROBAR GRIGIO	MICROBAR RIGHT POWDER COLLECTION TRAY GREY
05000717		GALLEGGIANTE SPIA GRIGLIA POGGIATAZZE	WARNING FLOAT
05000719		CHIUSURA SUP. SCIVOLO DECAFFEINATO MICROBAR NERO	MICROBAR DECAFFEINATED CHUTE UPPER COVER BLACK
05000719.G		CHIUSURA SUP. SCIVOLO DECAFFEINATO MICROBAR GRIGIO	MICROBAR DECAFFEINATED CHUTE UPPER COVER GREY
05000725		SCIVOLO CAFFE' DX MICROBAR	MICROBAR RIGHT COFFEE CHUTE
05000726		CHIUSURA SCIVOLO CAFFE' DX MICROBAR	MICROBAR RIGHT COFFEE CHUTE COVER
05000728		SUPPORTO BECCO EROGAZIONE MICROBAR	MICROBAR SUPPLY SPOUT SUPPORT
05000729		BECCO EROGAZIONE MICROBAR GRIGIO	MICROBAR SUPPLY SPOUT GREY
05000730		CHIUSURA SUPPORTO BECCO EROGAZIONE MICROBAR	MICROBAR SUPPLY SPOUT SUPPORT COVER
05000732		CONVOGLIATORE DECAFFEINATO MICROBAR	MICROBAR DECAFFEINATED CONVEYOR
05000735		SUPPORTO LANCIA VAPORE MICROBAR	MICROBAR STEAM PIPE SUPPORT
05000737		BOCCOLA ESPULSIONE GRUPPO MICROBAR	MICROBAR UNIT EJECTION BUSHING
05000738		PALETTA ESPULSIONE GRUPPO MICROBAR	MICROBAR UNIT EJECTION BLADE
05000740		TUBO EROGAZIONE GRUPPO MICROBAR	MICROBAR UNIT SUPPLY PIPE
05000742		PISTONE SUPERIORE D.43 GRUPPO MICROBAR	MICROBAR UNIT UPPER PISTON D.43
05000743		PISTONE INFERIORE D.43 GRUPPO MICROBAR	MICROBAR UNIT LOWER PISTON D.43
05000744.1		CHIOCCIOLA VITE MOVIMENTO T.N.	WOM GEAR
05000745		CONVOGLIATORE CASSETTO FONDI	DRIP TRAY CONVOYER
05000746		CLIP FERMATUBO D.8	PIPE CLIP D.8
05000751		PASSACAVO PVC NERO D12x17x7	PVC CABLE GROMMET BLACK D12x17x7
05000752		RACCORDO PORTATUBO TS 4	PIPE BRACKET FITTING TS 4
05000753		GOMMINO CORNICE CARENA MICROBAR D.6	MICROBAR D.6 BASE FRAME GROMMET
05000754		GOMMINO CORNICE CARENA MICROBAR D.4	MICROBAR D.4 BASE FRAME GROMMET
05000756		COPERC. CARENA MICROBAR 5LT 1M	MICROBAR COVER 5LT 1GRINDER
05000756.G		COPERCIO CARENA MICROBAR 5LT	MICROBAR COVER 5LT
05000757		COPERCIO CARENA MICROBAR 5LT 2 MACININI NERO	5 LITRE MICROBAR CASE COVER 2 GRINDERS BLACK
05000757.G		COPERCIO CARENA MICROBAR 5LT 2 MACININI GRIGIO	5 LITRE MICROBAR CASE COVER 2 GRINDERS GREY
05000758		COPERCIO VASCHETTA ACQUA 5LT MICROBAR NERO	WATER TRAY COVER 5LT MICROBAR BLACK
05000758.G		COPERCIO VASCHETTA ACQUA 5LT MICROBAR GRIGIO	WATER TRAY COVER 5LT MICROBAR GREY
05000759		COLLETTORE CONTENITORE ACQUA 5LT MICROBAR	5 LITRE MICROBAR WATER CONTAINER PIPE
05000765		SCIVOLO CAFFE' FISSO SX MICROBAR	MICROBAR LEFT FIXED COFFEE CHUTE
05000766		SCIVOLO CAFFE' MOBILE SX MICROBAR	MICROBAR LEFT MOBILE COFFEE CHUTE
05000767		SNODO SCIVOLO CAFFE' MOBILE MICROBAR	MICROBAR MOBILE COFFEE CHUTE JOINT
05080038		PIEDINO	FOOT
05180005		SUPPORTO POMPA A L	L-SHAPED PUMP BRACKET
06200050		CALDAIA SUP. LAVORATA	TOP HALF BOILER
06200051		CALDAIA INF. LAVORATA	BOTTOM HALF BOILER
07300001		RACCORDO L 1/8" M-M	L FITTING 1/8" M-M
07300004		RACCORDO 1/8"-1/8"	FITTING 1/8"-1/8"
07300129		TAPPO 1/8 GAS	TAP 1/8 GAS
07300203		PORTAGOMMA CILINDRICO 1/8"	CYLINDRICAL HOSE CLAMP 1/8"
07300218		RACCORDO A L 1/8" M-F	L FITTING 1/8" M-F
07300342		PERNO SUPPORTO CENTRALINA	CONTROL UNIT SUPPORT PIN
07300363	01/09/2007	RACCORDO DOPPIO 6 1/4 380A	DOUBLE FITTING 6 1/4 380A
07300369		RACCORDO ATTACCO DIRETTO PER	FITTING DIRECT DISCHARGE
07300375		RACC. L GIR.6 1/8 VITON 346 A	I FITTING 1/8 VITON 346 A
07300376		RACCORDO DIRITTO F 6 1/8"	STRAIGHT FITTING F 6 1/8"
07300501		ALBERO PALETTA ESPULSIONE GRUPPO MICROBAR	MICROBAR UNIT EJECTION BLADE SHAFT
07300503		ALBERO PISTONE INFERIORE SCARICO GRUPPO MICROBAR	MICROBAR UNIT DRAIN LOWER PISTON SHAFT
07300505		BOCCOLA ALBERO PISTONE SCARICO GRUPPO MICROBAR	MICROBAR UNIT DRAIN PISTON SHAFT BUSHING
07300507		BOCCOLA FLANGIATA	FLANGED BUSHING
07300508		COLONNA D.12 GRUPPO MICROBAR	COLUMN D.12 MICROBAR UNIT
07300512		PIATTELLO PORTAMOLLA INFERIORE GRUPPO MICROBAR	MICROBAR UNIT LOWER SPRING WASHER
07300513		PIATTELLO PORTAMOLLA SUPERIORE GRUPPO MICROBAR	MICROBAR UNIT UPPER SPRING WASHER
07300519		VITE MOVIMENTO GRUPPO MICROBAR	MICROBAR UNIT MOVEMENT SCREW
07300522		VITE REGOLAZIONE MACINATURA MICROBAR	MICROBAR GRINDING ADJUSTMENT SCREW
07300526		RACCORDO PORTAGOMMA 1/8" M 120°	HOSE CLAMP FITTING 1/8" M 120°
07300529		MANICOTTO FILETTATO 1/8	THREADED SLEEVE 1/8"
07300530		RACCORDO L 1/8" F A CALZAMENTO D6	L FITTING 1/8" F SHEATH TYPE D6
07300538		RACCORDO RAPIDO 1/4 DIRITTO D4	RAPID FITTING 1/4" STRAIGHT D4
07300539		RACCORDO RAPIDO 1/8" DIRITTO D4	QUICK COUPLING 1/8" STRAIGHT D4

